

Article number: 0106090

Description: Retaining ring JV 85

## Measures

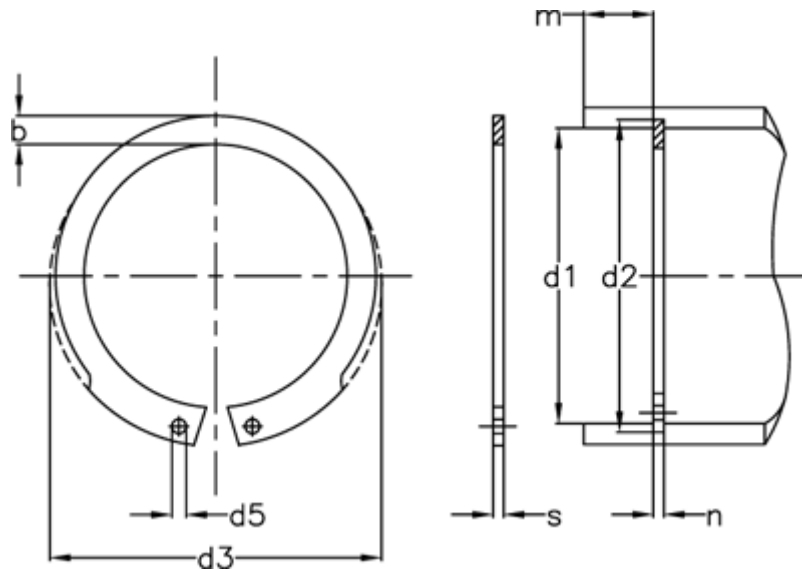

AN mm <sup>2</sup>	= 238	FRg kN	= 3.0	tol	= 0.3
b	= 6.6	FR kN	= 176.0	tol	= -0.08
d1	= 85	g	= 3.0	tol	= +0,31-0,54
d2	= 88.5	K kN-mm	= 318.0	tol	= +0,35
d3	= 90.5	m min	= 3.15	Tong	= ZGJ-3
d5 min	= 3.0	Nominal drive	= 5.3	Weight kg/1000	= 30.00
Description	= JV 85	s	= 3.00		
FN kN	= 39.70	t	= 1.75		